



University of Brighton



Advanced Engineering Centre, University of Brighton
Research Seminar

Aerosols: environmental, technological and health science applications

S.K. Zaripov

Kazan Federal University, Kazan, Russia

Definition

Aerosol is a suspension of solid or liquid particles in a gas.

Examples: dust, clouds

Bioaerosols: aerosols of biological nature (viruses, bacteria, fungi, spores, pollens)

Aerosol sources

Nature aerosols

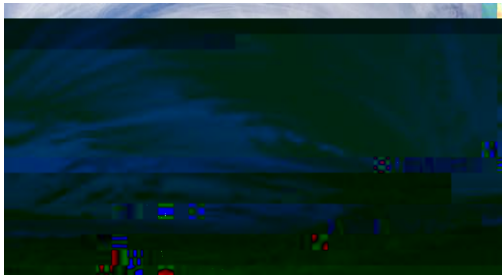

Sea aerosols



Dust-storm-Texas-1935

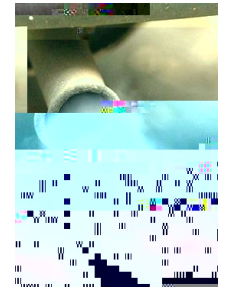

clouds



Smoke from forest fires
Sheremetyevo 2010 08 07

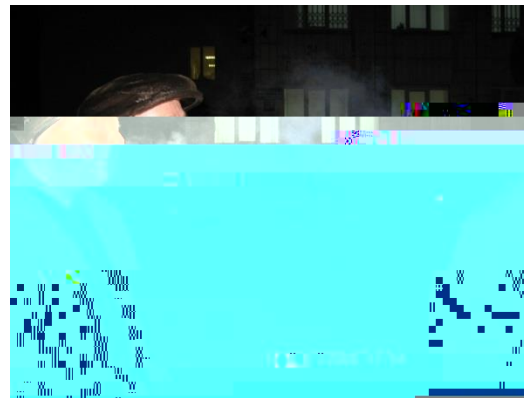

tobacco smoke



sneeze particles

car emissions

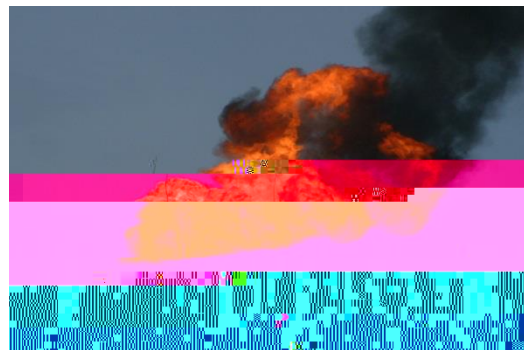

industrial fire

Aerosol particle sizes

The range of diameters of aerosol particles is 10^{-8} - 10^{-4} m = T f 1 0 0 1 440.54 45.7 T m

Aerosol problems

Monitoring

Health related problems

Air cleaning air filtration

Aerosol technology

Course aerosols

Inertia

Gravity

Ultrafine particles

Diffusion

Phoretic forces (thermophoresis, diffusiophoresis, photophoresis)

Electrostatic forces

Human inhalability - aerosol influence

Environment

Workplace

< 100 μm

PM10

inhalable

thoracic

< 10 μm

PM2.5

respirable

PM1

< 5 μm

PM0.1

Ultrafine

Nanoparticles

Nanoparticles

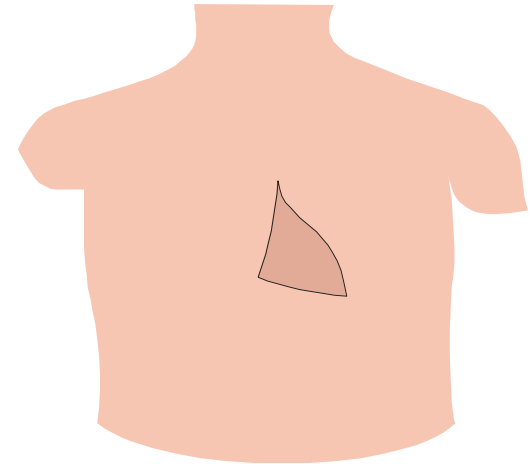

From the lecture of Prof. W.Koch, Fraunhofer ITEM, June, 2014, Kazan

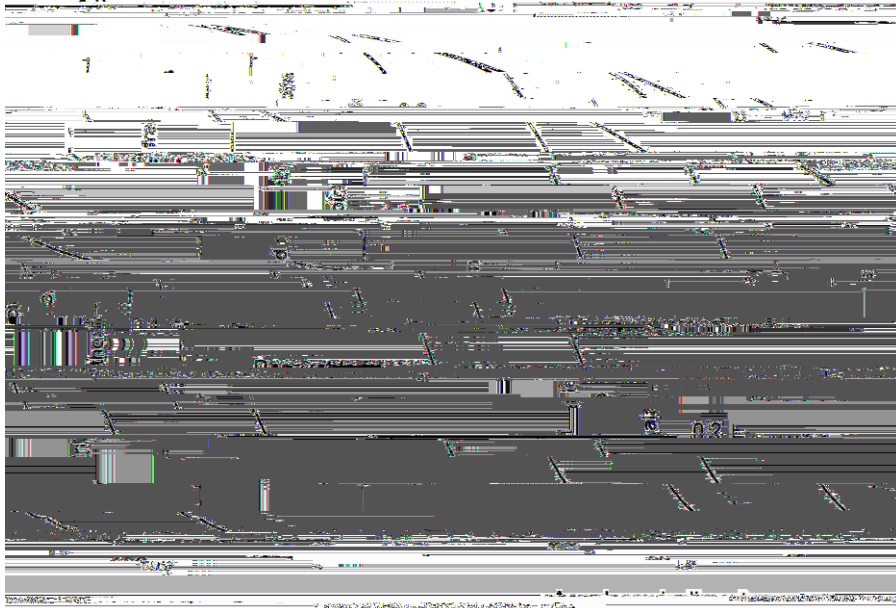

Curves of inhalable, thoracic and respirable dust fractions

Aerosol monitoring – aerosol sampling

Various sampler inlets

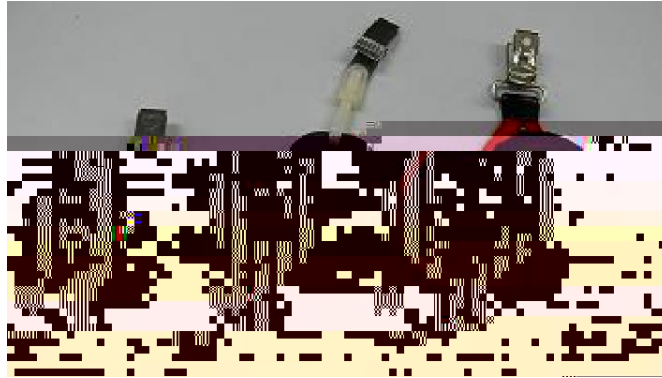
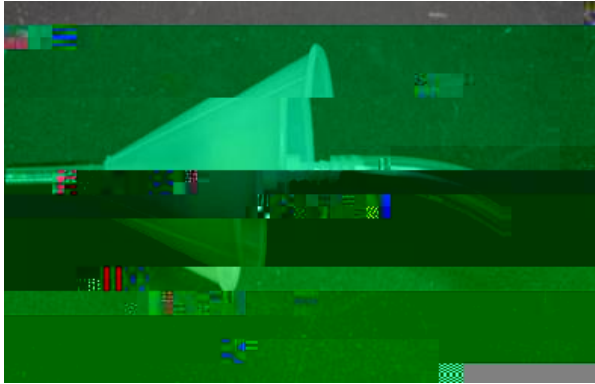

Darrah K. Schmees , Yi-Hsuan Wu and James H. Vincent

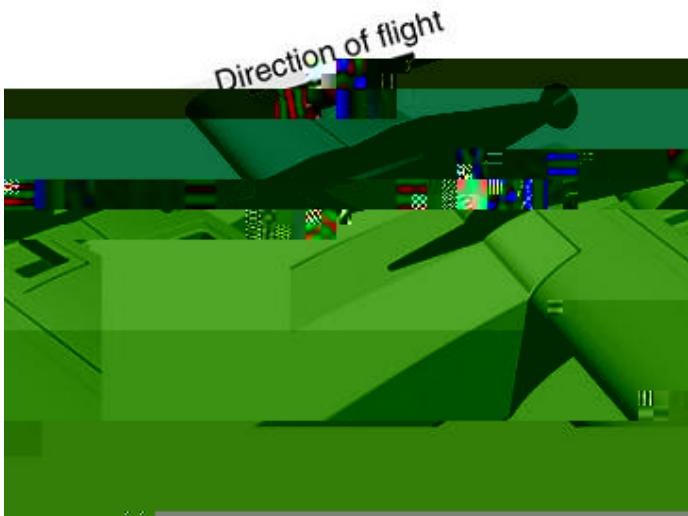

Respicon

Aspiration efficiency

$$A = \frac{C_i}{C_0}$$

C_i

C_0



$$A = f(R_a, d_p, f_p, L_i, St, v_s, Re, B)$$

Sampling in moving air

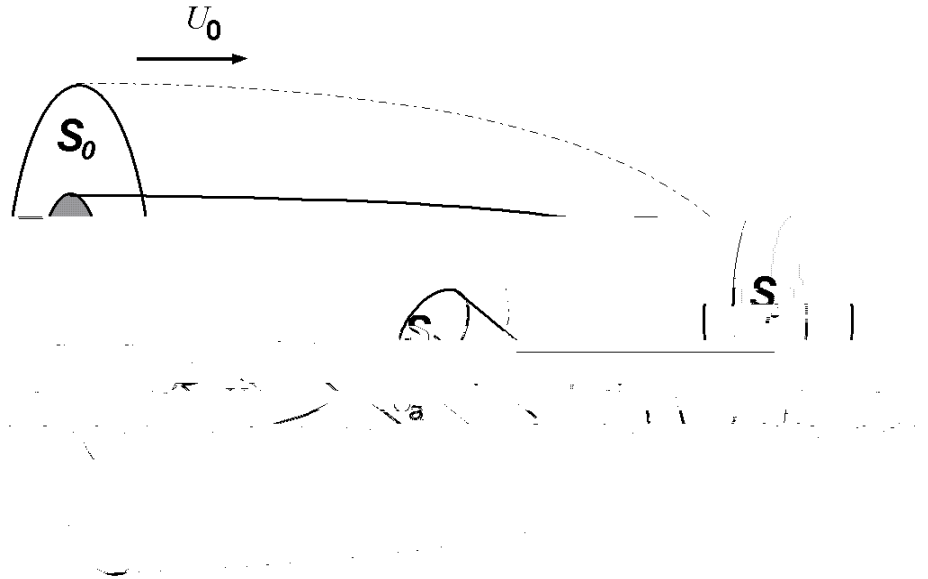

$$A(t) = \frac{N_a(t - \frac{1}{4}t)}{N_0(t)} \frac{\int_{S_a} c_a(x, y, t - \frac{1}{4}t) v_{pa}(x, y, t - \frac{1}{4}t) dy dx}{\int_{S_0} c_0(x, y, t) v_{p0}(x, y, t) dy dx}$$

Lagrangian equations of particle motion

$$m \frac{d\bar{v}}{dt} = m \bar{u} \cdot \bar{v} + m\bar{A} \cdot t + m\bar{g} + \bar{F}_e$$

Aerodynamic drag

Brownian force

gravity force

electrostatic force

$$3d a d / c_s m$$

\bar{v} $\bar{v}(x, y, z)$ particle velocity
 \bar{u} $\bar{u}(x, y, z)$ air velocity

a viscosity

d particle diameter

m particle mass

C_s Cunningham correction factor

Thin walled sampler for very small velocities ratio

S.K. ZARIPOV, A.K. Gilfanov, D.V. Maklakov Numerical study of thin-walled sampler performance for aerosols in low windspeed environments. Aerosol Science and Technology, 2010.

.....

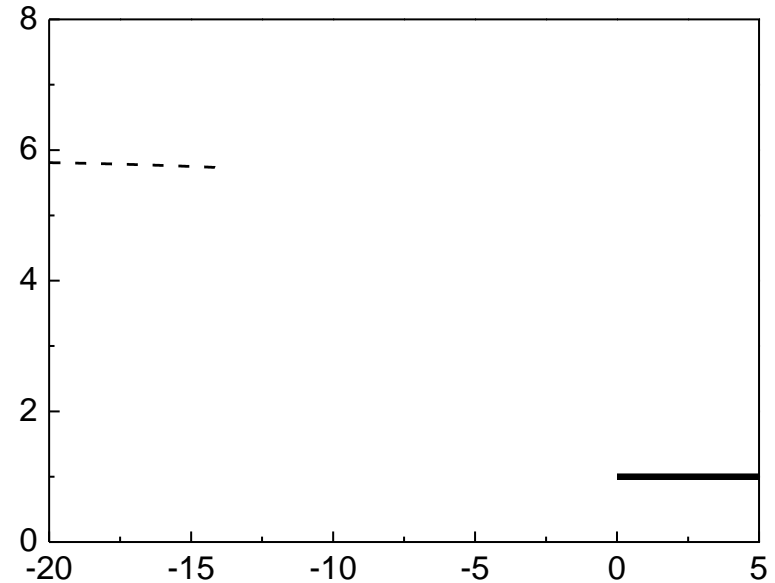
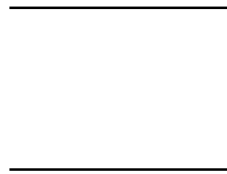

Comparison of $A_i(Ra)$ $A_e(Ra)$ and experimental data
Gibson&Ogden (1977) Davies&Subari (1982)

0,1

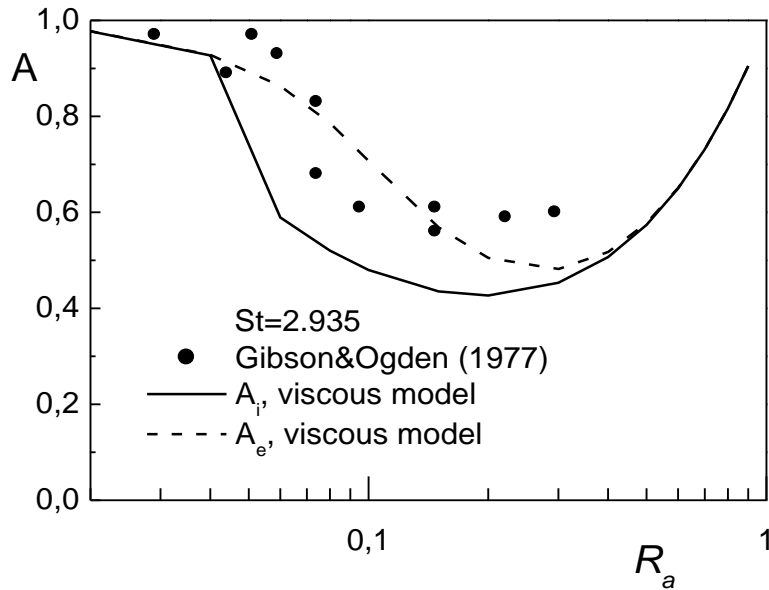

Particle concentration contours for $a=0.2$ (lines = particle trajectories)

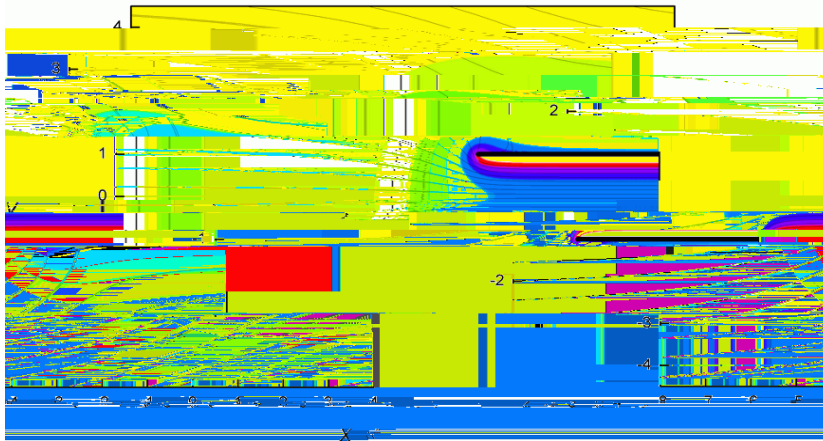

$St=0.01$

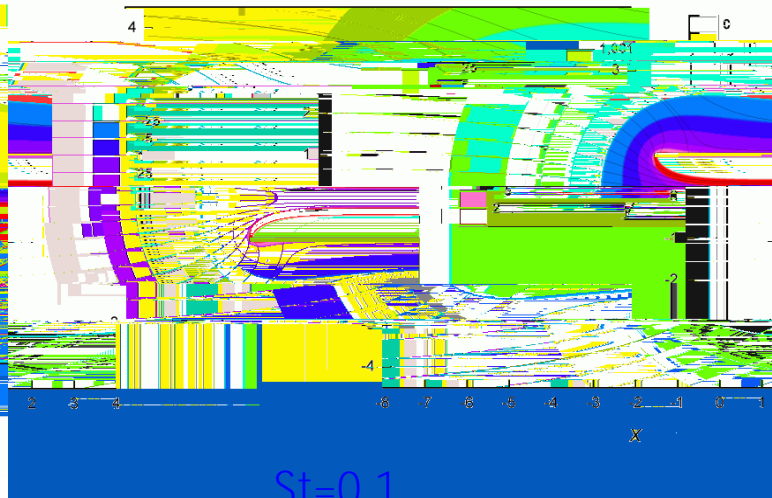

$St=0.1$

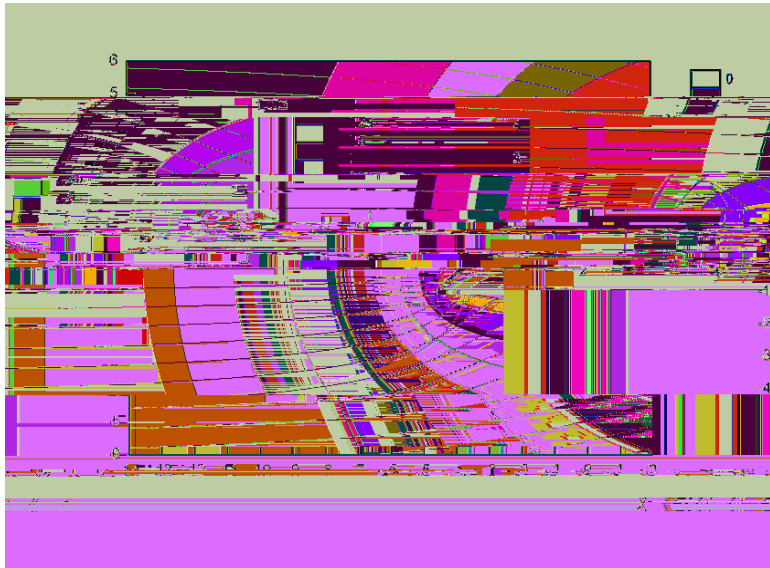

$St=1$

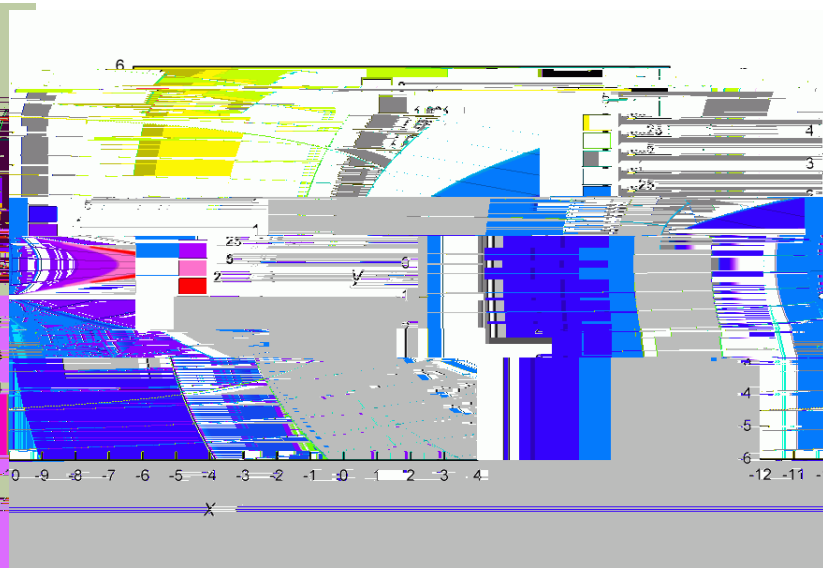

$St=10$

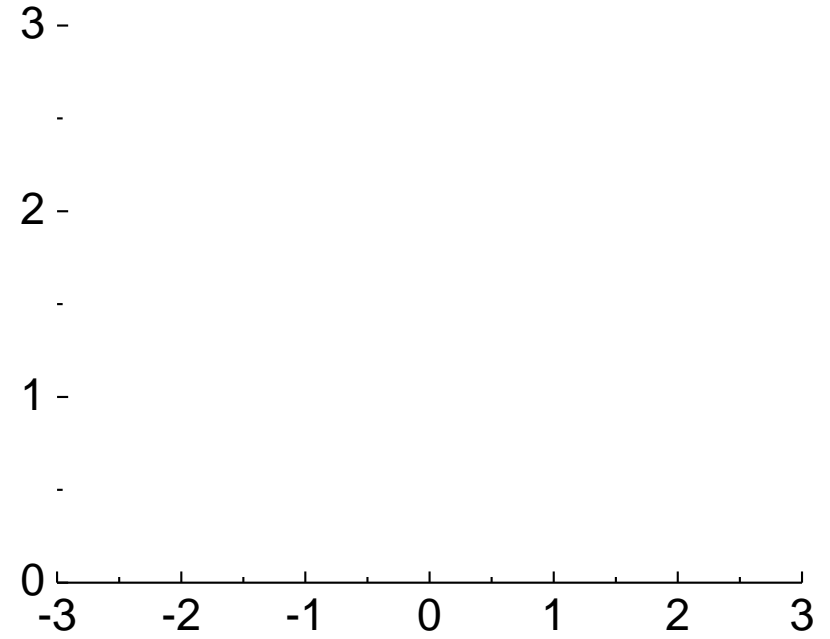
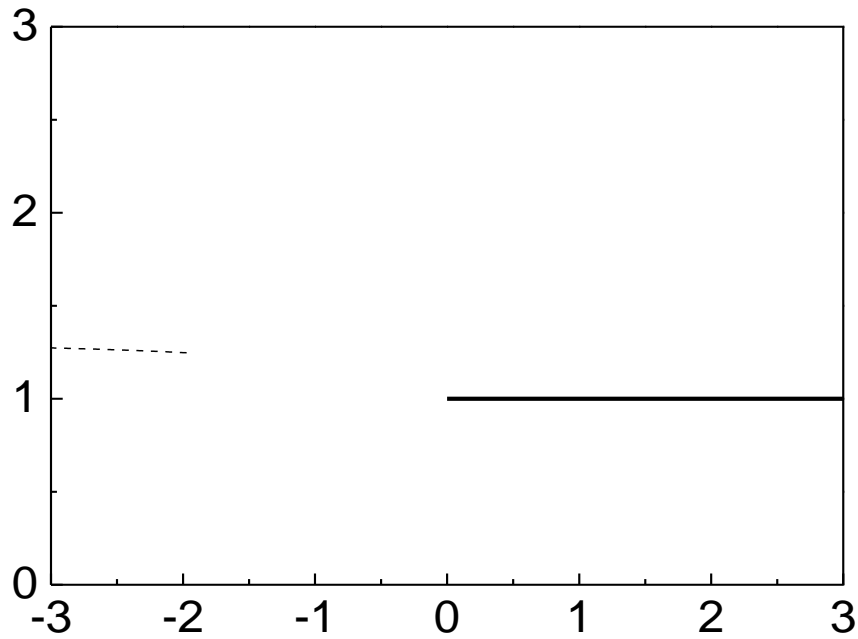

Particle trajectories and concentration isolines
 $R_a=0.2$ and $St=1$ for potential and viscous flows

Numerical study of performance of the RespiCon sampler in calm air

W. Koch et.al., 2009

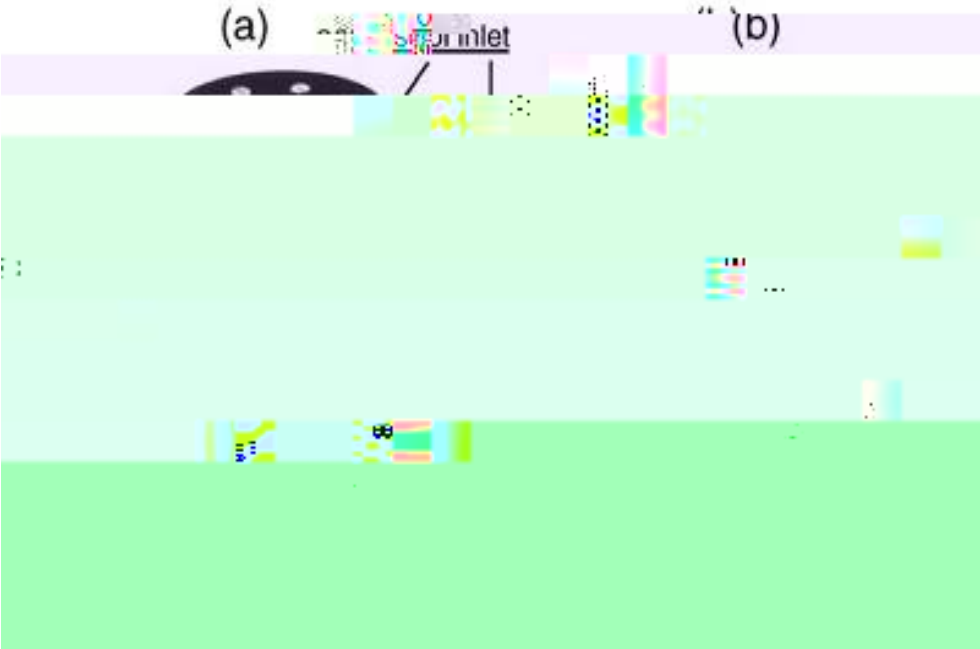

FRAUNHOFER INSTITUTE
TOXIKOLOGIE UND
EXPERIMENTELLE
MEDIZIN, HANNOVER

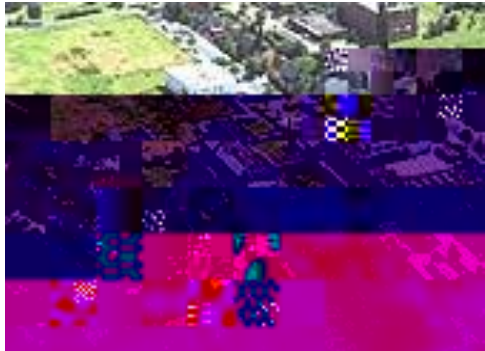

Numerical study of performance of the RespiCon sampler in calm air

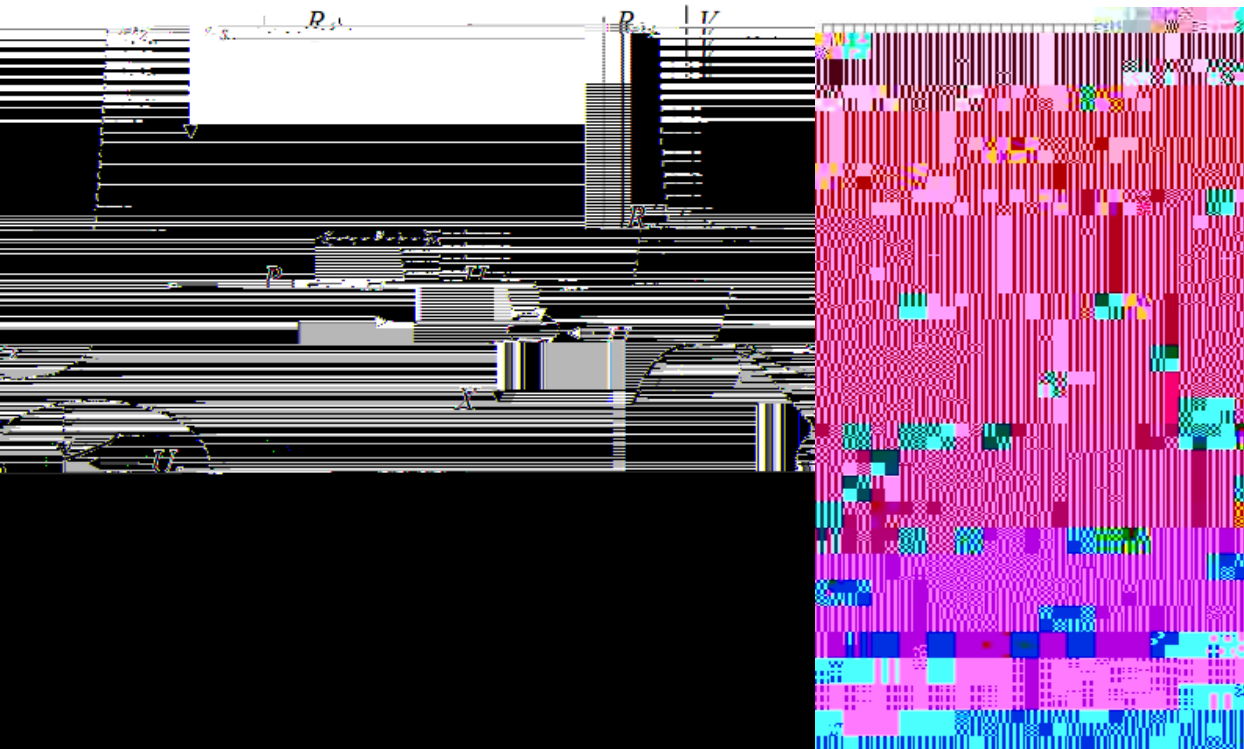

Fig. 2. RespiCon sampler scheme and mesh of calculation domain

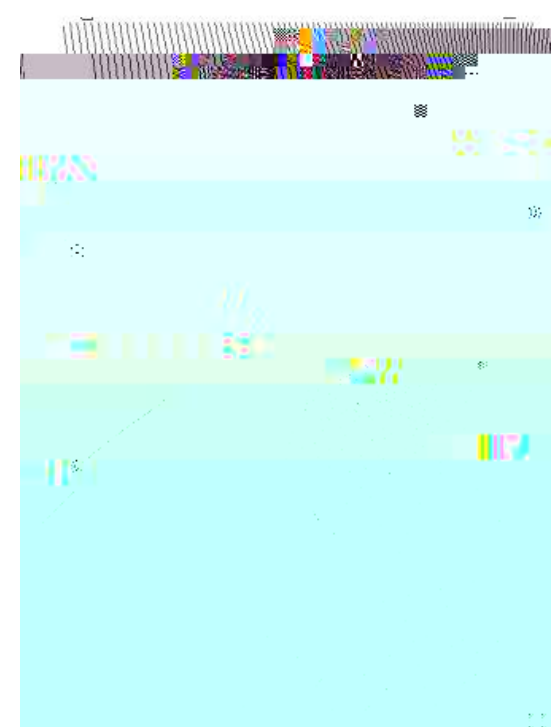
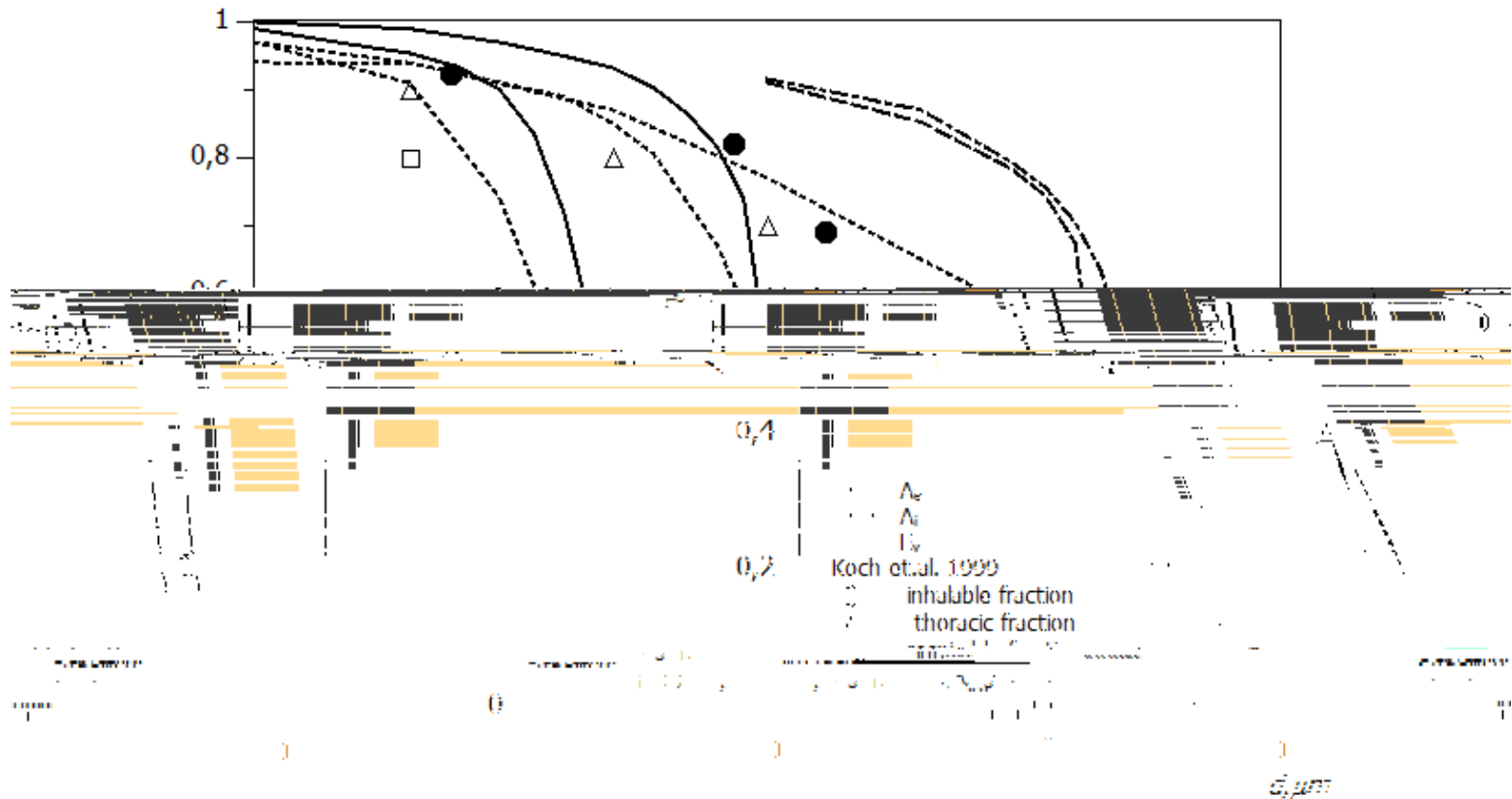

Fig. 4. Example of trajectories of particles impacting the slit wall

Collection efficiencies of RespiCon stages as a function of particle diameter



Sampling into spherical sampler in calm air

$$\bar{U}_0 = 0 \quad R_a = 0$$

$$= 12$$

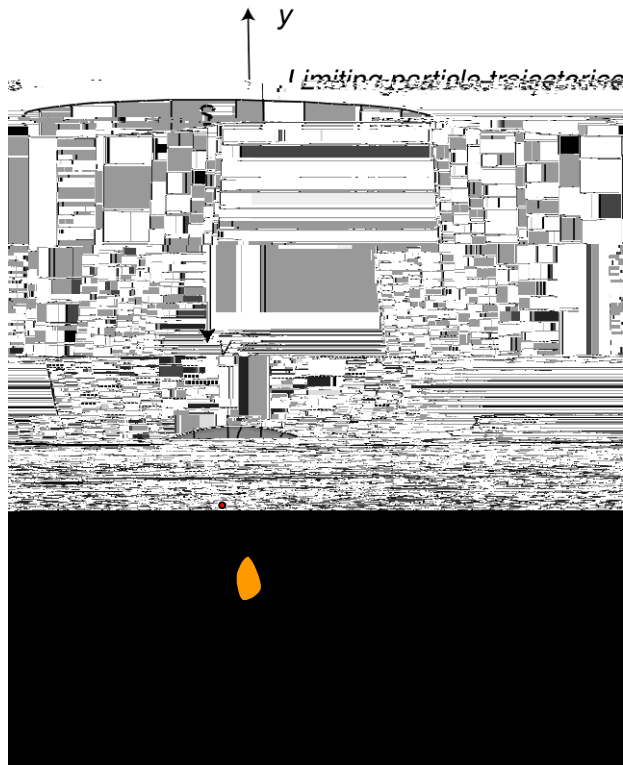

$$= 0$$

$$= 12$$

P

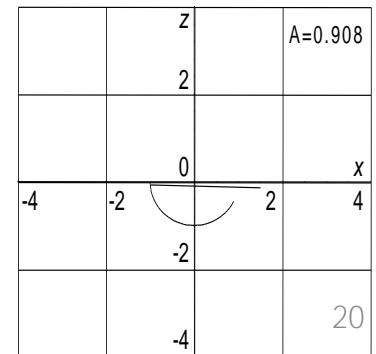
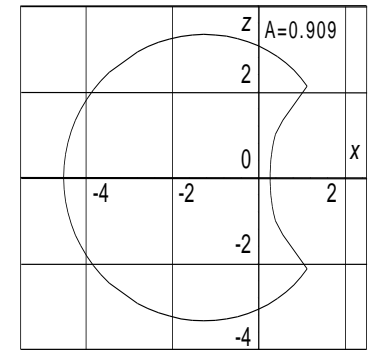

=d

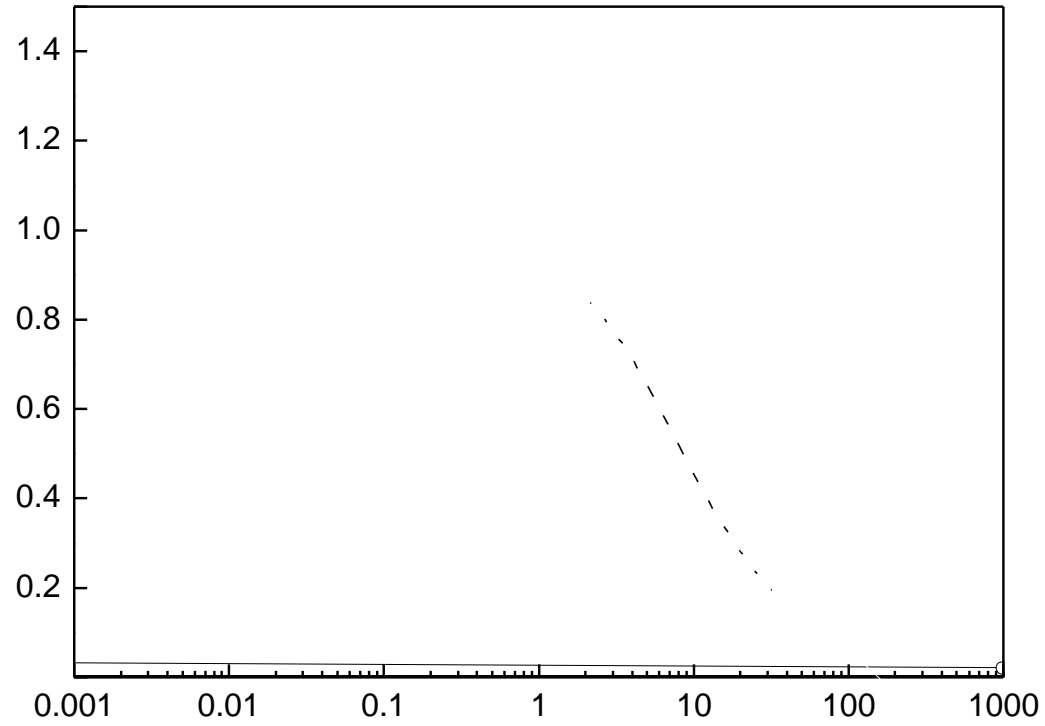

$A(St_c)$ $V_s=0.1$ 0.01



					
$R_a=0.15$	$R_a=0.1$	$R_a=0.075$	$R_a=0.05$	$R_a=0.025$	$R_a=0.0$

Fig.3.

$$A \quad 1 \quad k \quad k^2$$

$$k \quad \text{St}(R_a^2 \quad R_c^2)^{3/4} \quad 1$$

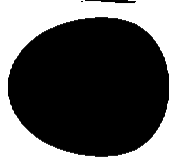
$$=-15.19, \quad =$$

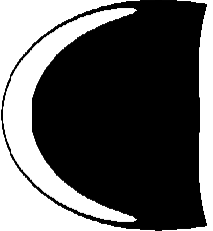
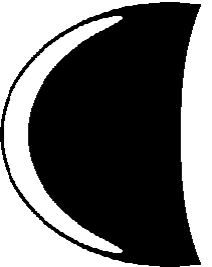
Aspiration efficiency - Inhalation fraction

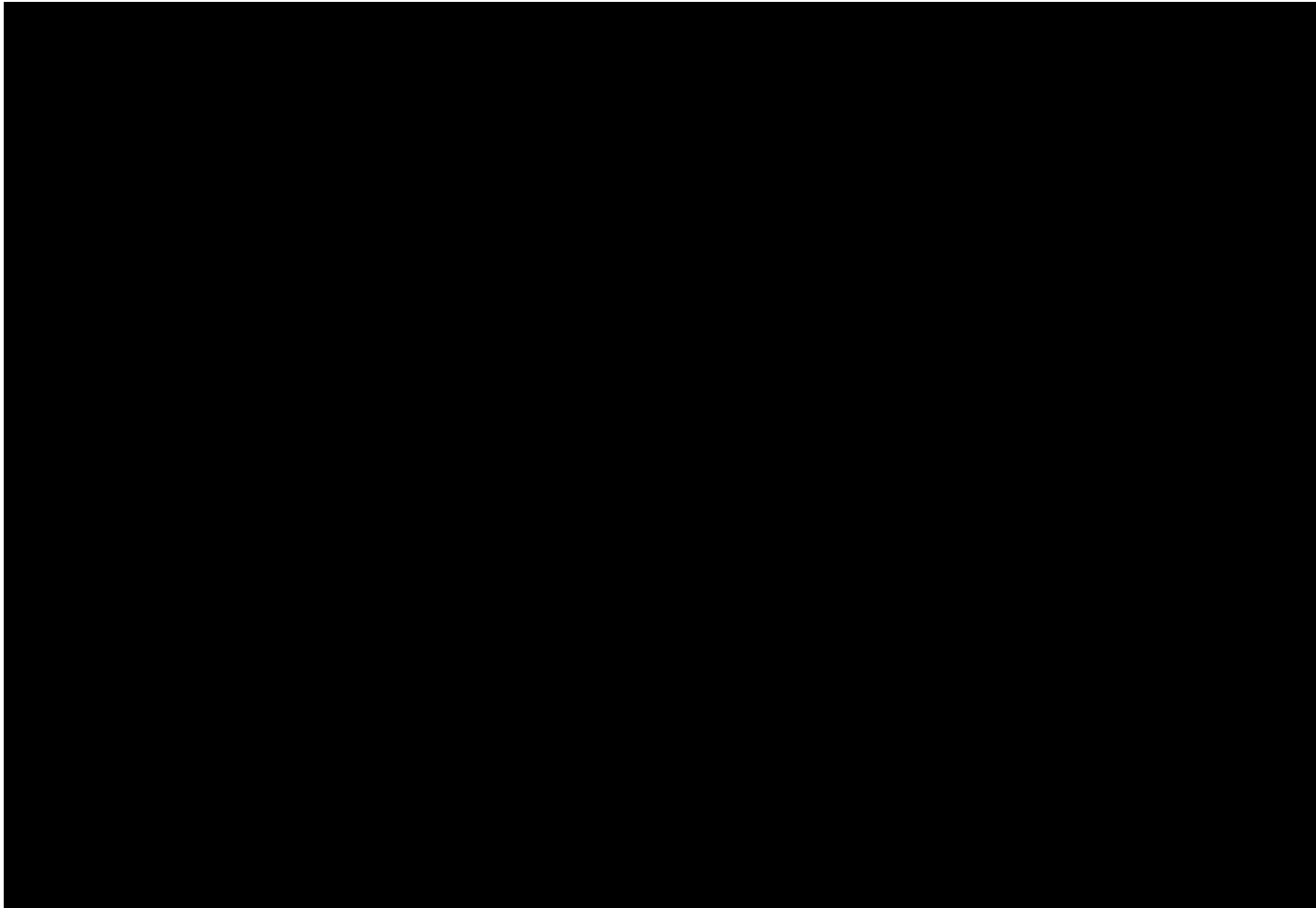

$$\text{IPM} = 0.5(1 - \exp(-0.06d_p))$$

The criterion for inhalable particulate mass (IPM) from the American Conference of Governmental Industrial Hygienists (ACGIH)

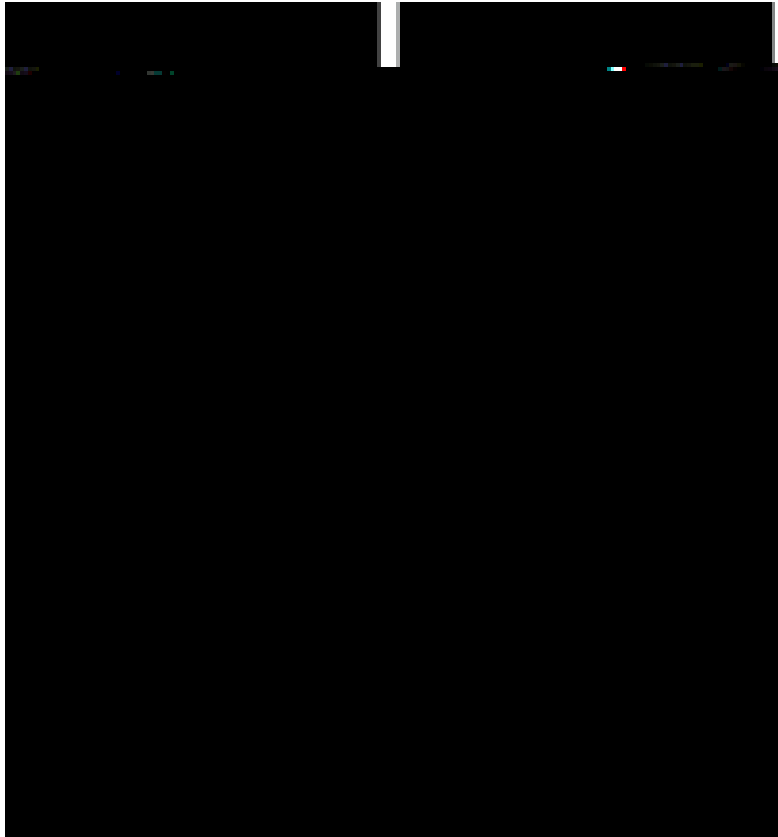

Darrah K. Schmees , Yi-Hsuan Wu and James H. Vincent

Experimental methods to determine inhalability and personal sampler performance for aerosols in ultra-low windspeed environments

J. Environ. Monit., 2008

CFD model of aerosol flow in the vicinity of manikin head

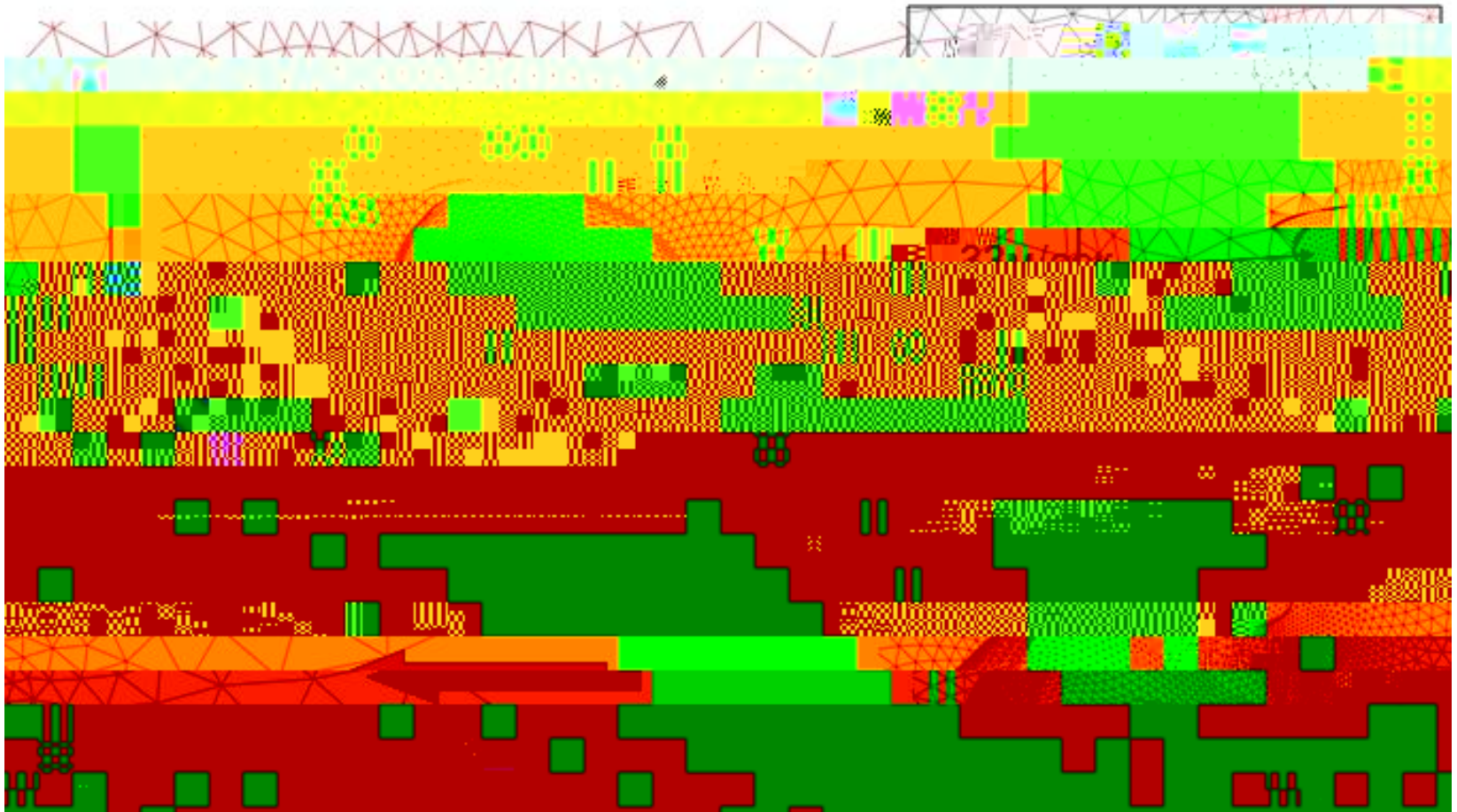

Meshing in the vicinity of manikin head

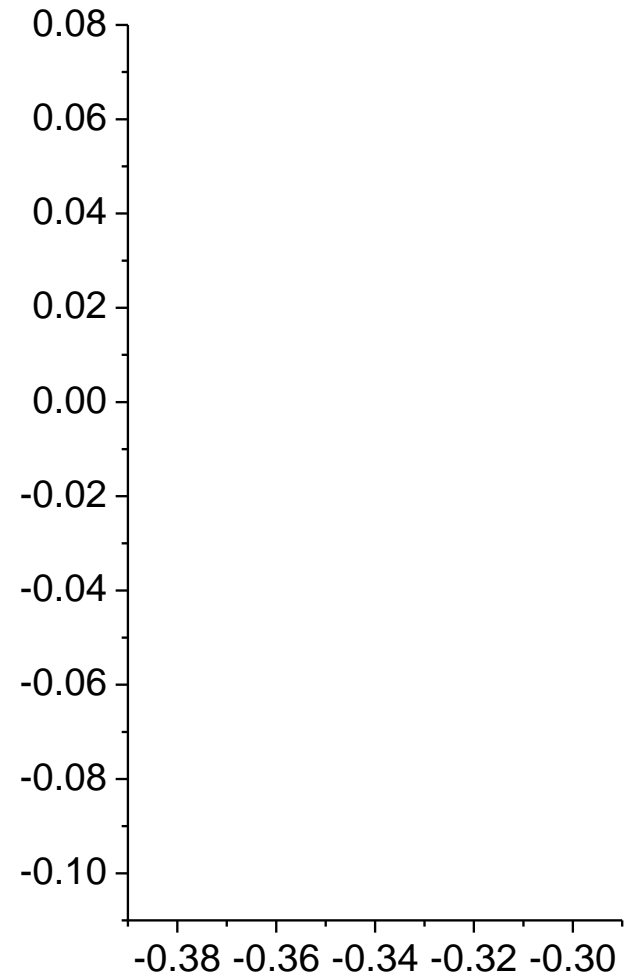
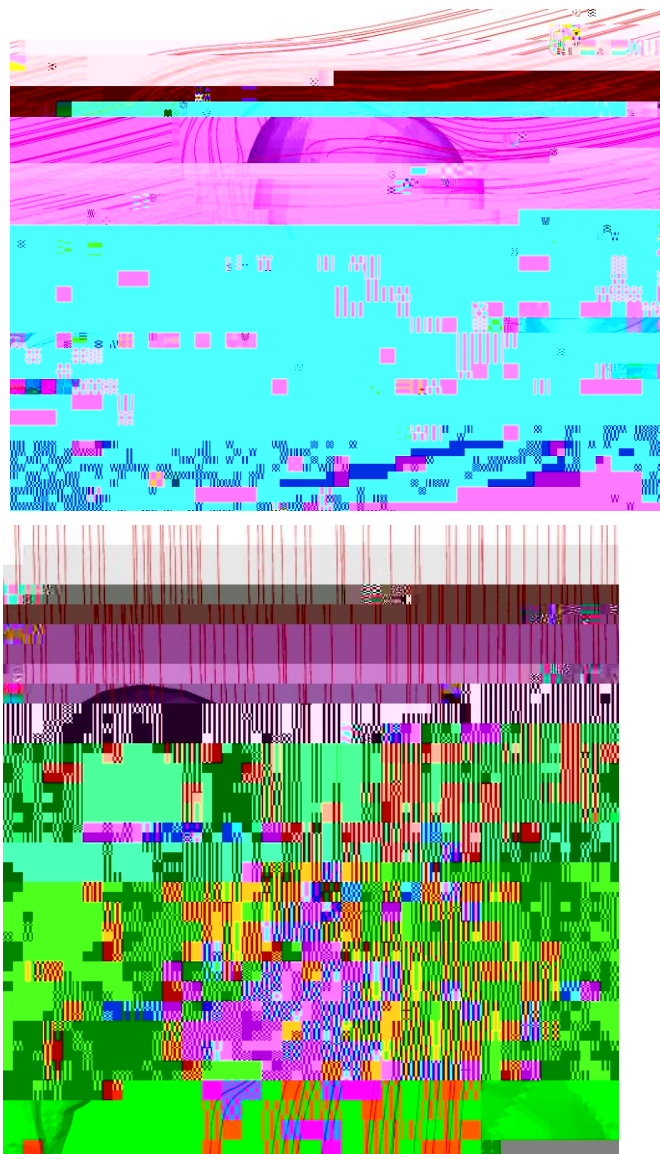

The trajectories of particles at $d=37\mu\text{m}$ for two wind velocities: a- $U_0=0.2$ m/s, b - $U_0=0$

The area S_p of the aspirated particles

Inhalable fraction for breathing through mouth (1) and nose (2) in calm air

Facepiece filtering respirators (FFR) and surgical masks

Variety of respirator facepieces



Performance evaluation on a manikin headform



Two pathways of particle penetration

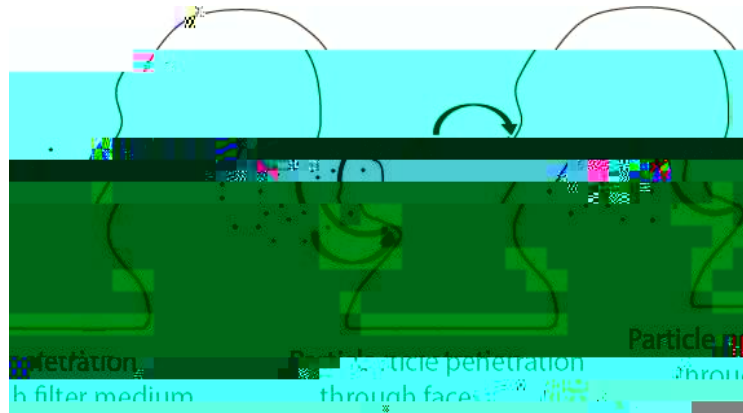

$$\text{Protection factor} = C_{\text{out}}/C_{\text{in}}$$
$$\text{Particle penetration} = C_{\text{in}}/C_{\text{out}}$$

Experimental (combining manikin-based and human study protocols):
Grinshpun et al. (2009).

Leak flux / Filter flux

Particle diameter (μm)

An

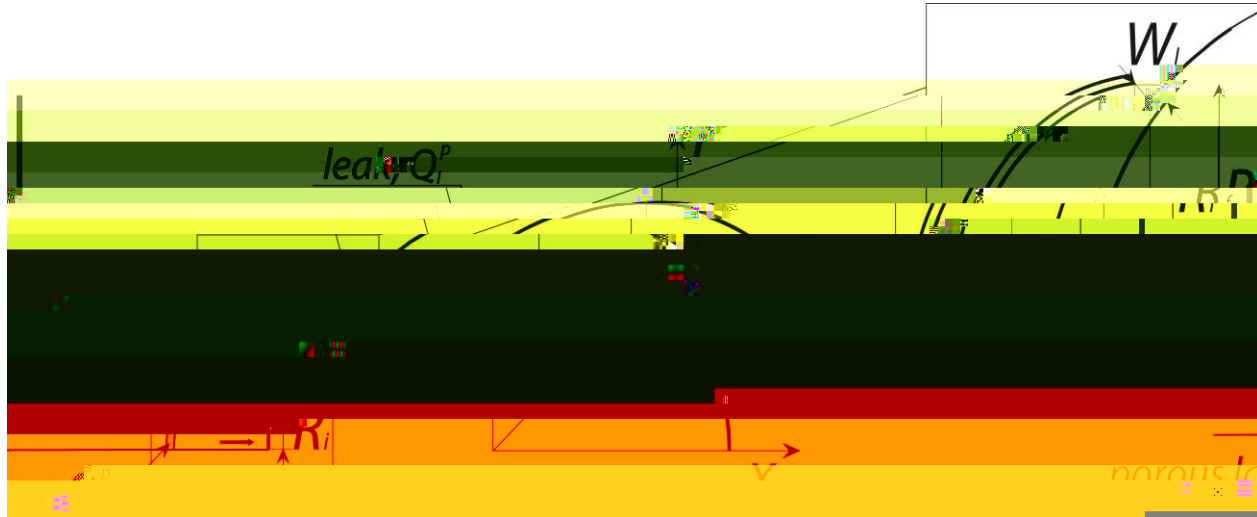

Penetration of aerosol particles through filter layer

$$I_f = \exp\left(-\frac{4 E_f L}{d_f (1 - \epsilon_f)}\right)$$

Fitting the porous layer permeability to the experimental curves $f(d_p)$ from Rengasamy and Eimer (2012)

Kozeny-Carman formula:

$$k = \frac{\gamma^3 d_{fiber}^2}{180(1 - \gamma)^2}$$

Permeability used for calculations:

$$k = 9.55 \cdot 10^{-11} \text{ m}^2$$

The particle penetration through the filter $f(d_p)$ at $Q_i = 30 \text{ l min}^{-1}$

- 1 approximated formulas $d_{fiber} = 0.069$, $L = 3 \text{ mm}$
- 2 experimental values from Rengasamy and Eimer (2012).

Parameters and conditions used in the modeling

$$R_i = 0.007 \text{ m} \quad (S_i = 0.000154 \text{ m}^2)$$

$$R_h = 0.09 \text{ m}$$

spherical segment with
a height of H

Comparison to the experimental data of Rengasamy and Eimer (2012)

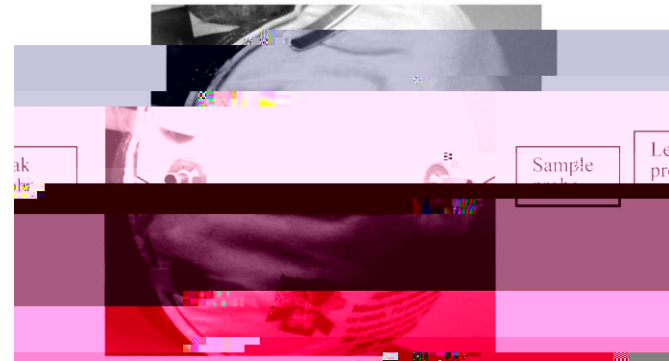

MODELING RESULTS:

$TIL = f(S_l/S_f)$ at $d_p = 50$ nm (a), 100 nm (b), and 1 μm (c)
for different inhalation flow rates

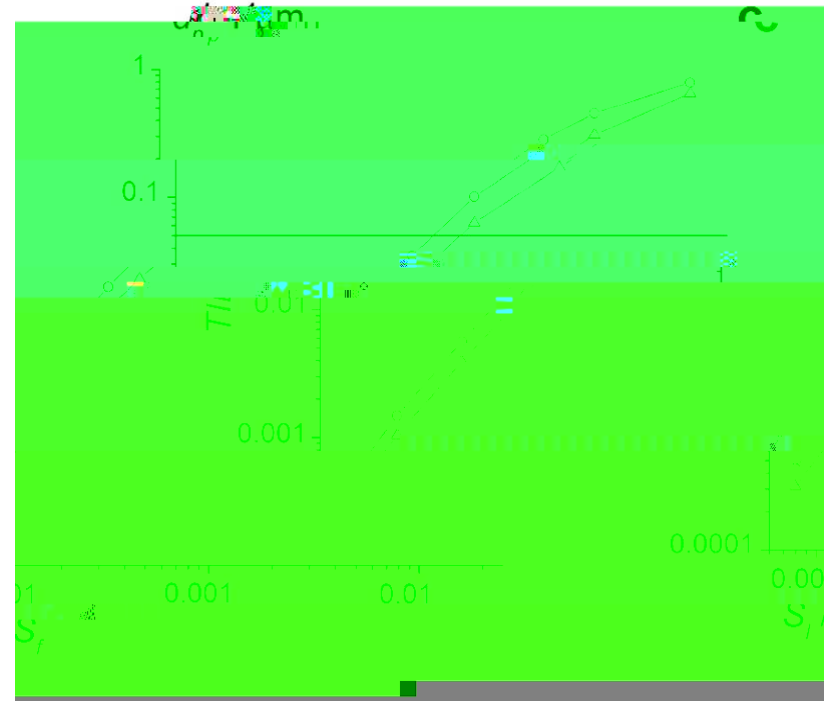
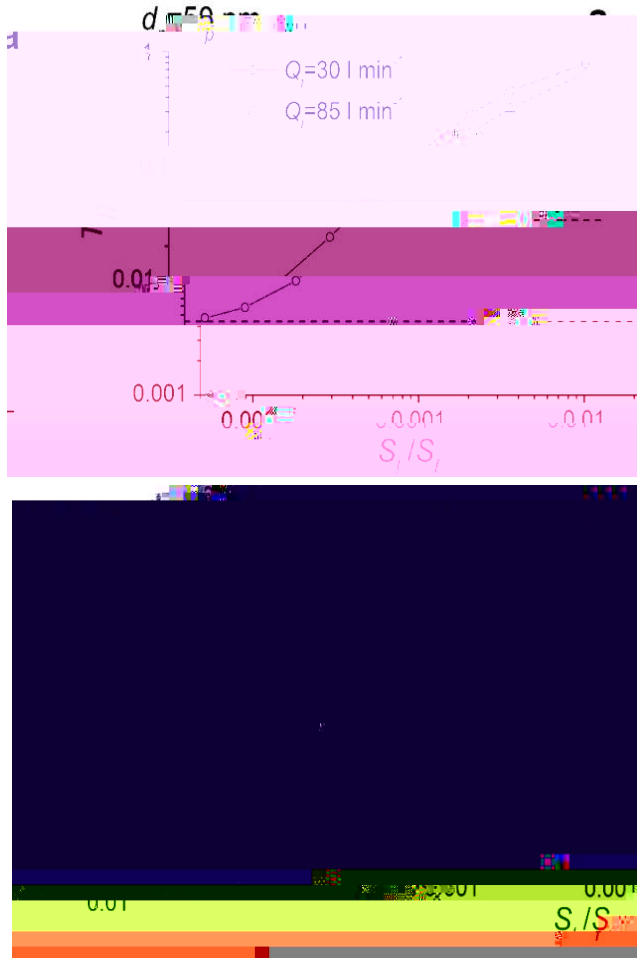

Solid lines represent the target value for an N95 ($TIL=0.05$).

Dotted lines represent a “perfect fit” respirator (with no facesal leakage).

NUMERICAL STUDY OF GROWING DROPLETS DYNAMICS IN UNSTEADY THERMAL CONVECTION FLOW

S.K. ZARIPOV , R.S.Galeev , W.Holländer. Numerical study of dynamics of growing droplets in Kelvin spectrometer. Abstracts of European Aerosol Conference-2007, Salzburg, T12A033.

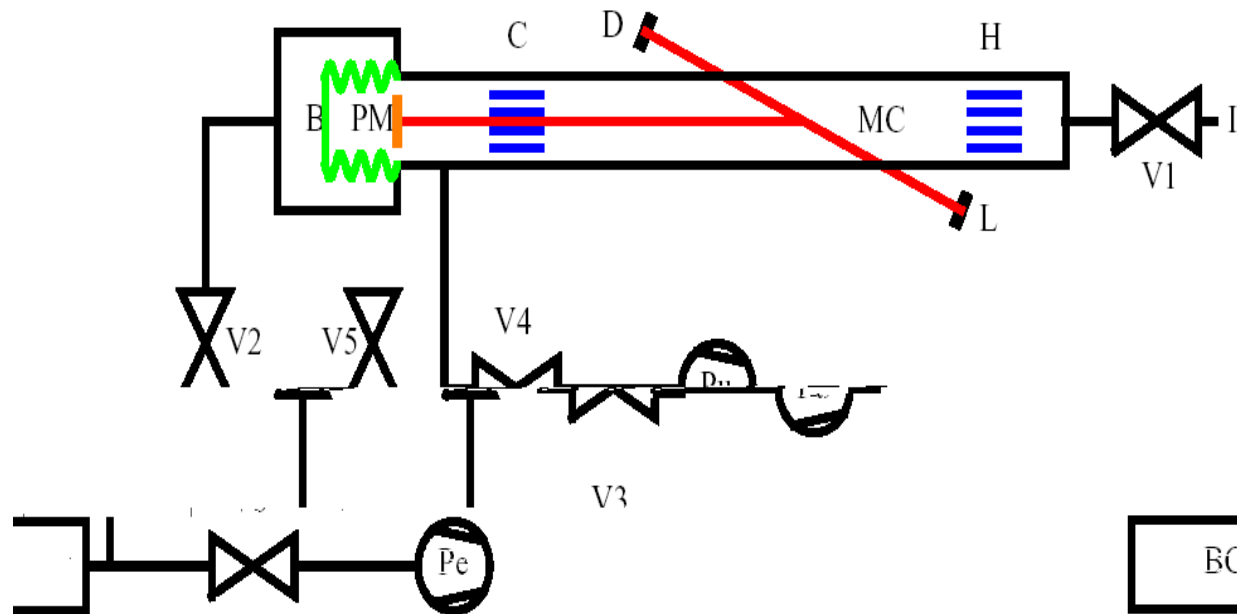

The main channel is equipped with a fund of particles in the form of a shadow. Figure 1. The...

Fig.8. Time evolution of the temperature distribution in the cross section of the horizontal cylinder

$$T_w(\bar{r}_p, t)$$

1s

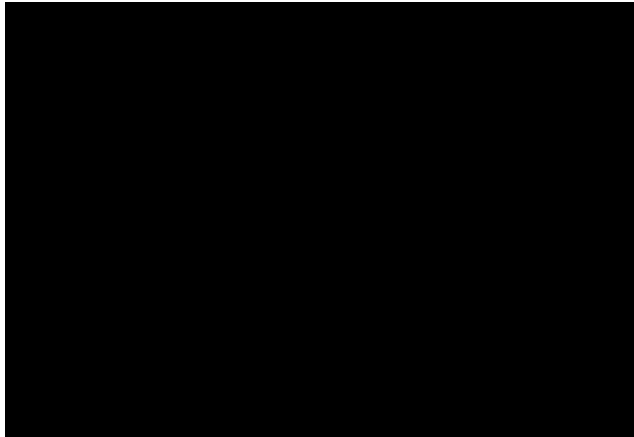

2s

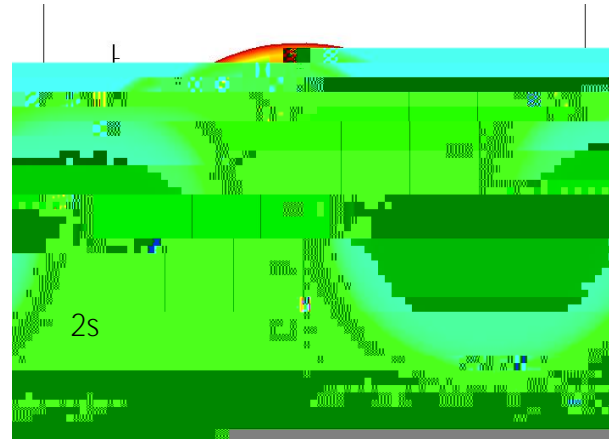

2s

5s

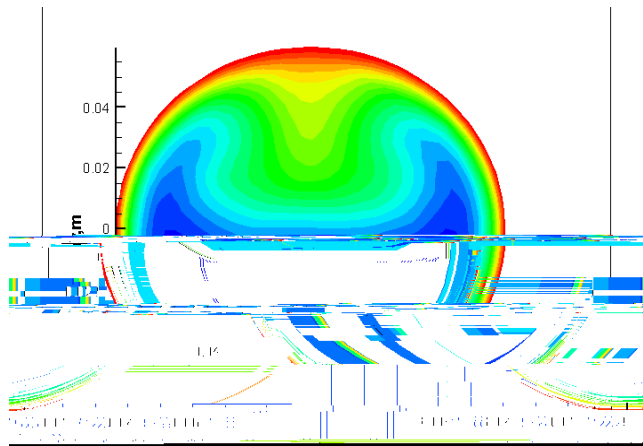

10s

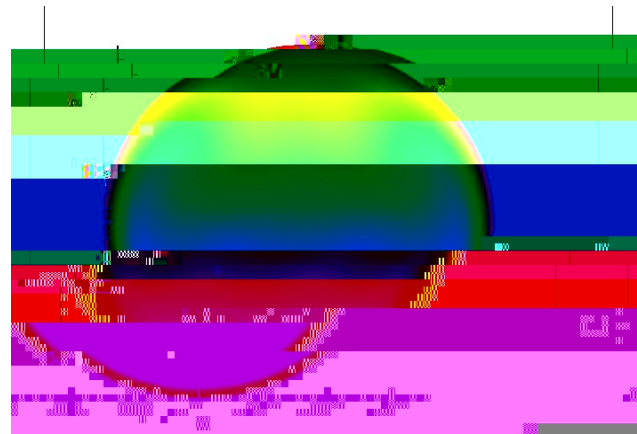

$$\bar{U}(\bar{r}_p, t)$$

1s

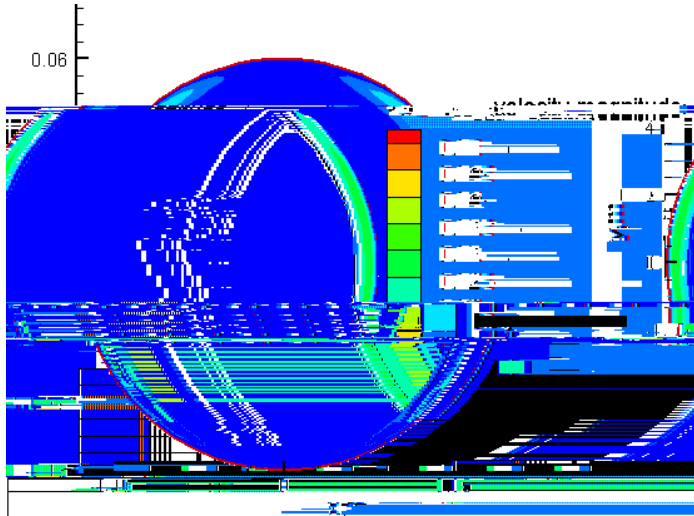

2s

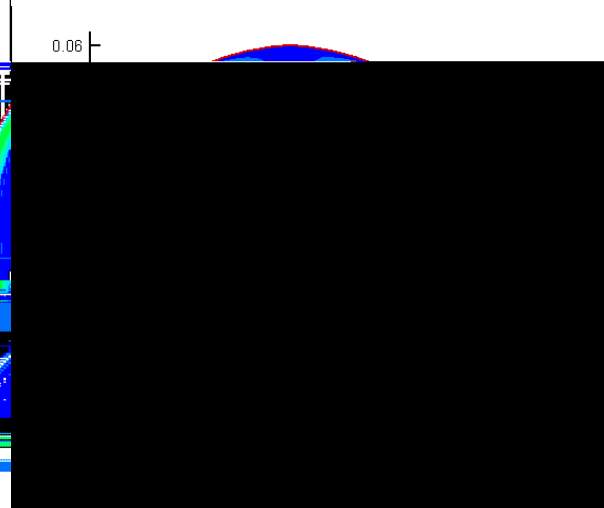

5s

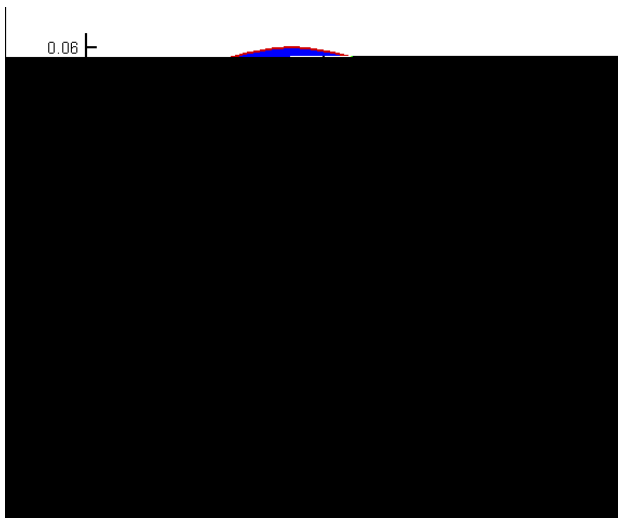

10s

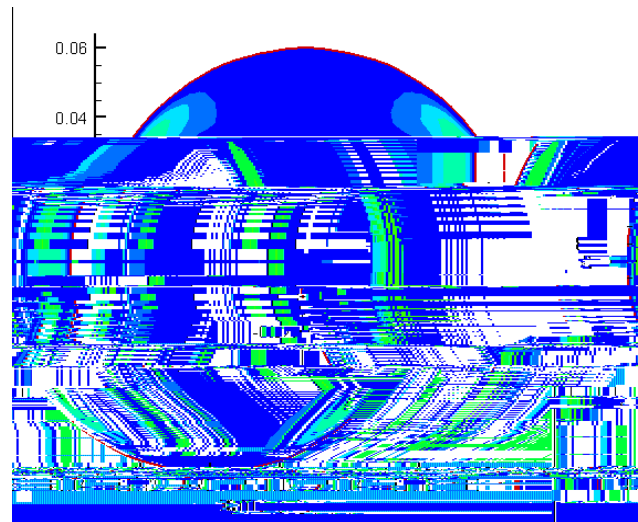

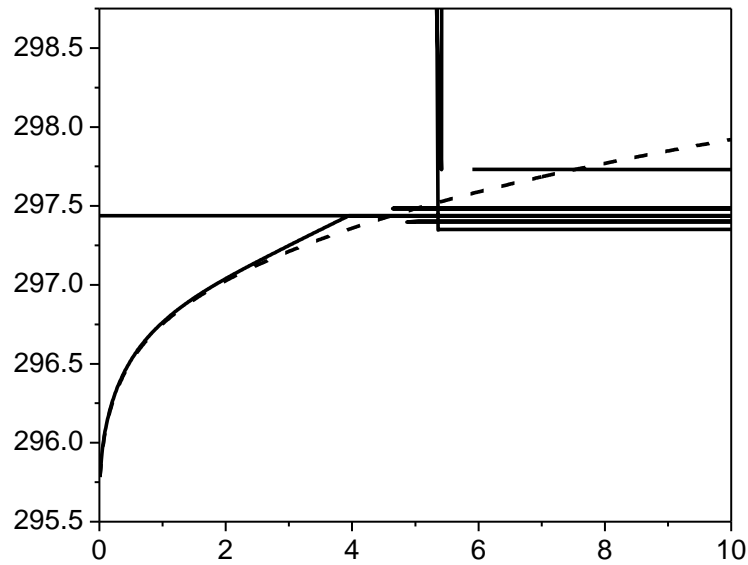

Fig.7. Average gas temperature with and without convection influence

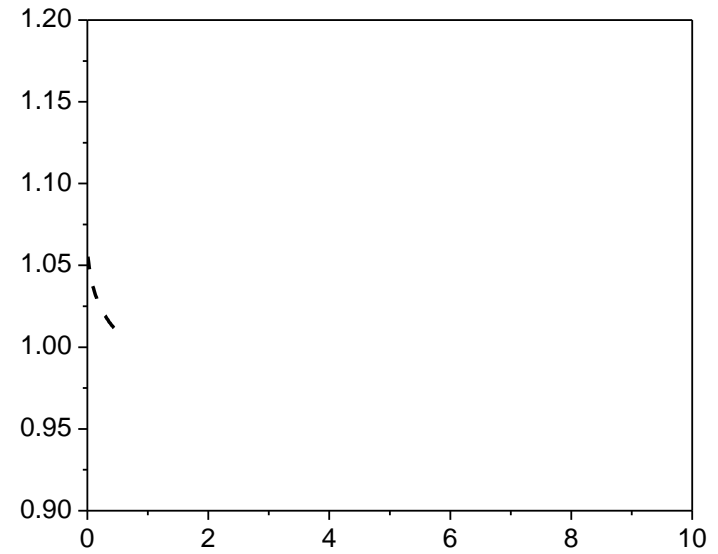

Fig.8. The saturation based on the average temperature gas temperature with and without convection influence

2019年1-9月中国主要农产品进口量

单位:万吨

来源:海关总署



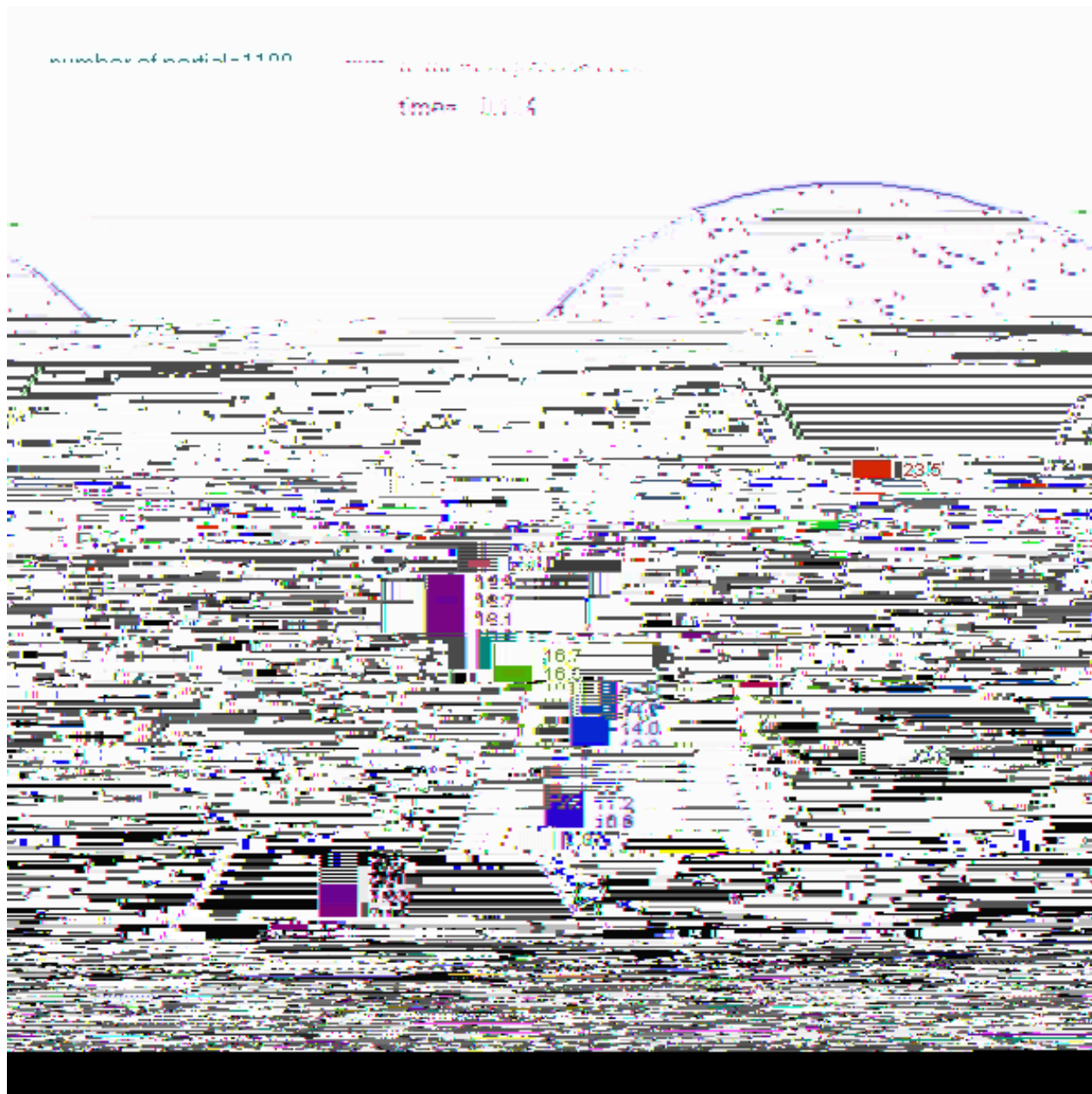
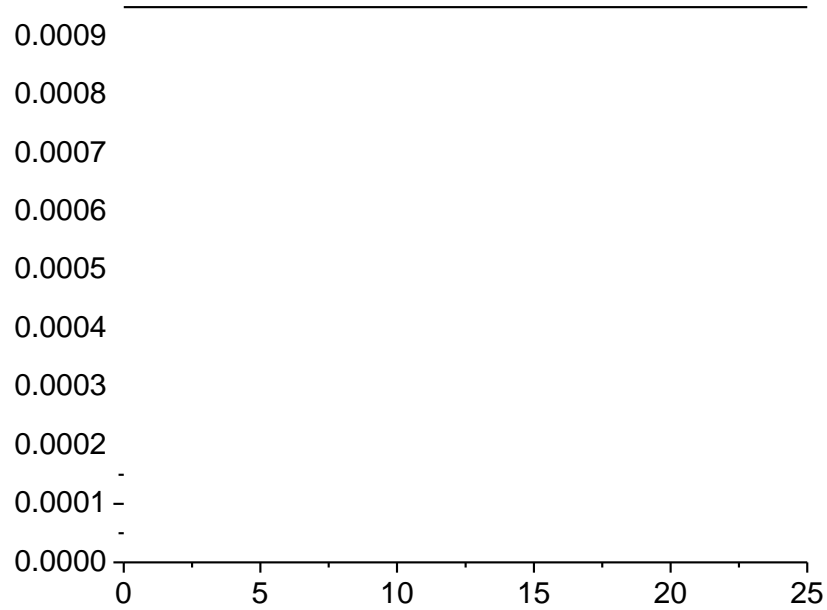
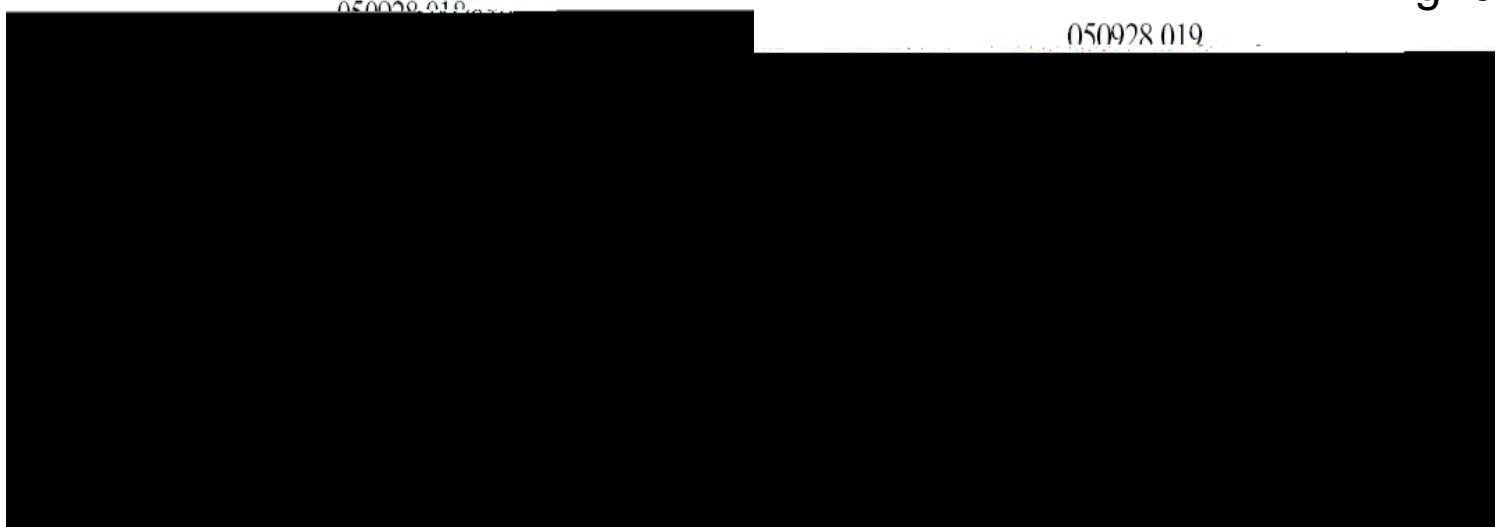

Fig.14. The mass density of condensing vapor on all droplets for $N=1000 \text{ cm}^{-3}$ and various initial saturations



$g=9.81\text{m/s}$

$g=0$



Transport equation

$C(\bar{r}, t)$ - particle concentration

$J_D = -D \nabla^2 C$ Diffusion flux

$J_u = C \bar{U}$ convective transport

$$\frac{\partial C}{\partial t} = D \nabla^2 C - \bar{U} \cdot \nabla C + \text{sources/sinks}$$

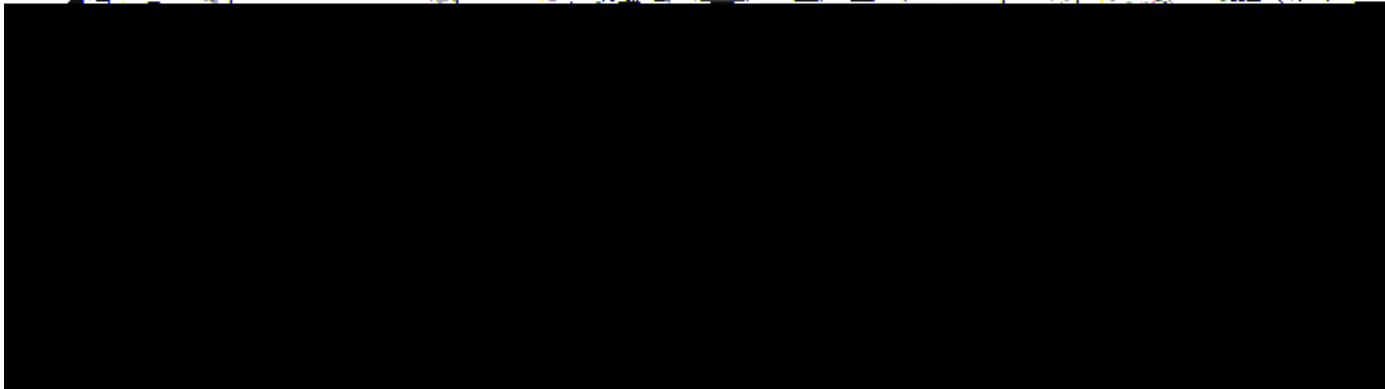
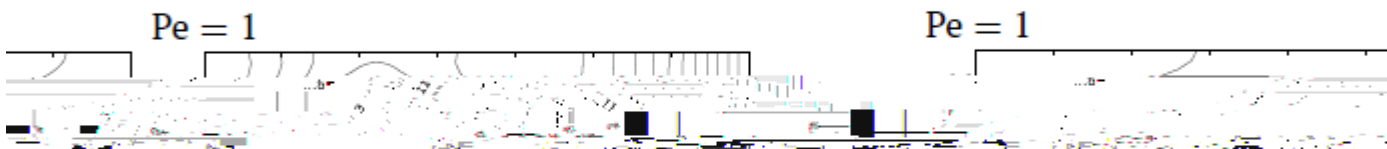
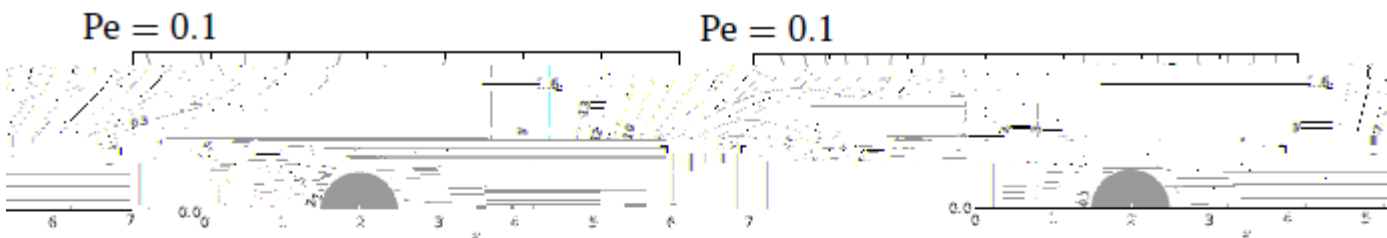
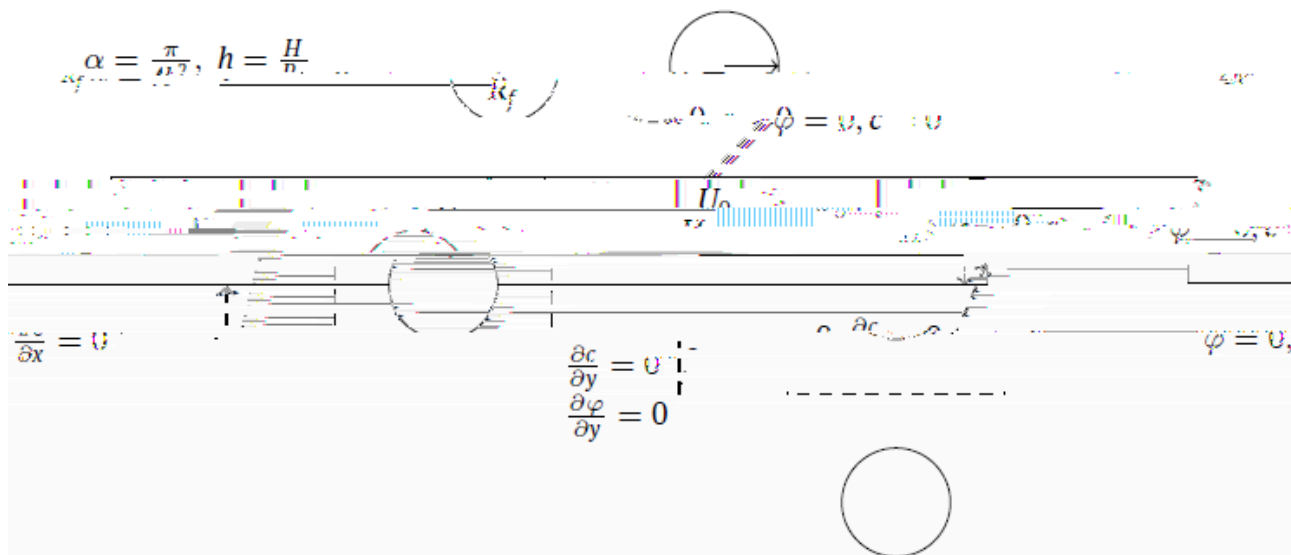

Deposition efficiency

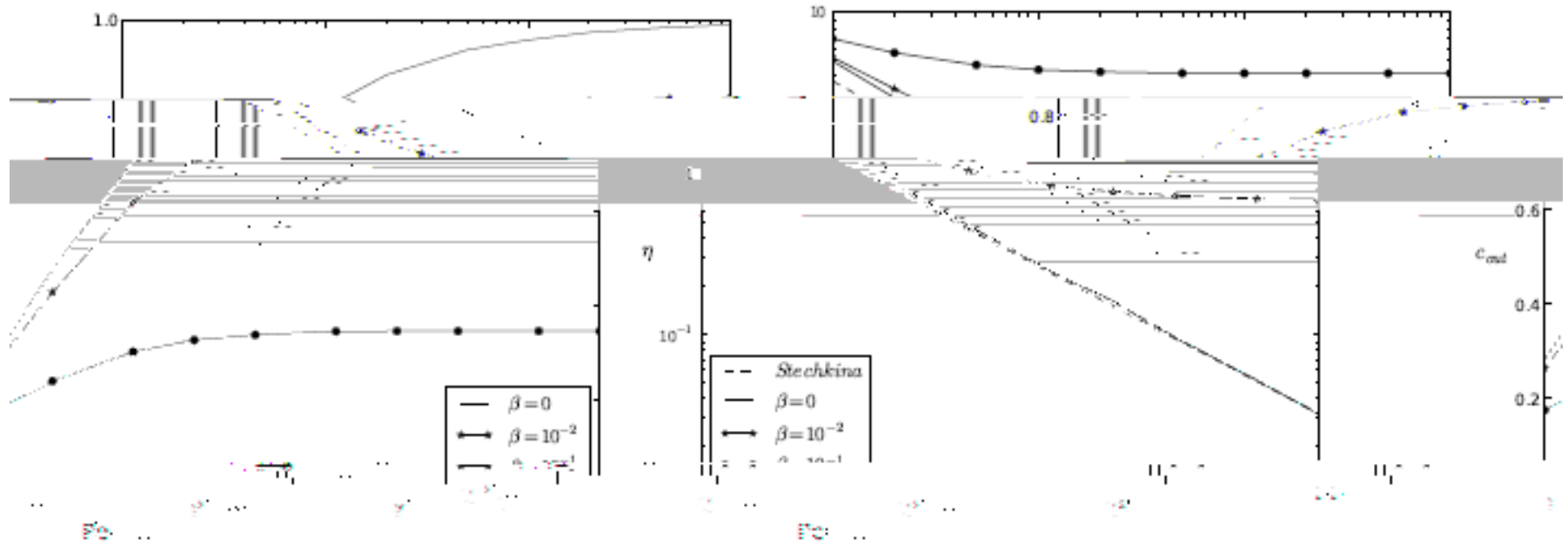

Aerosol deposition on the porous cylinder

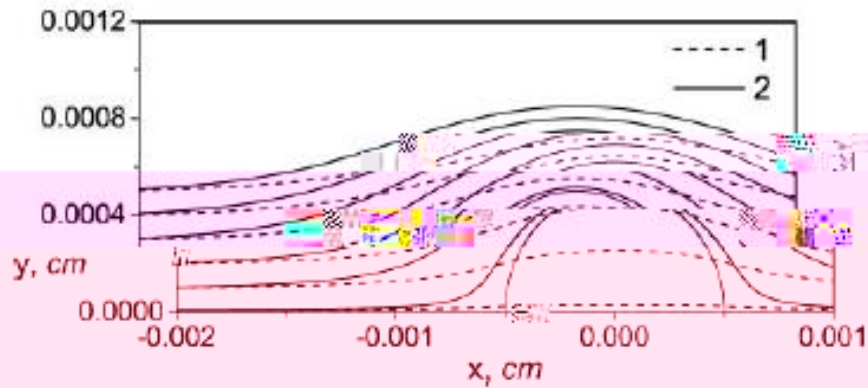
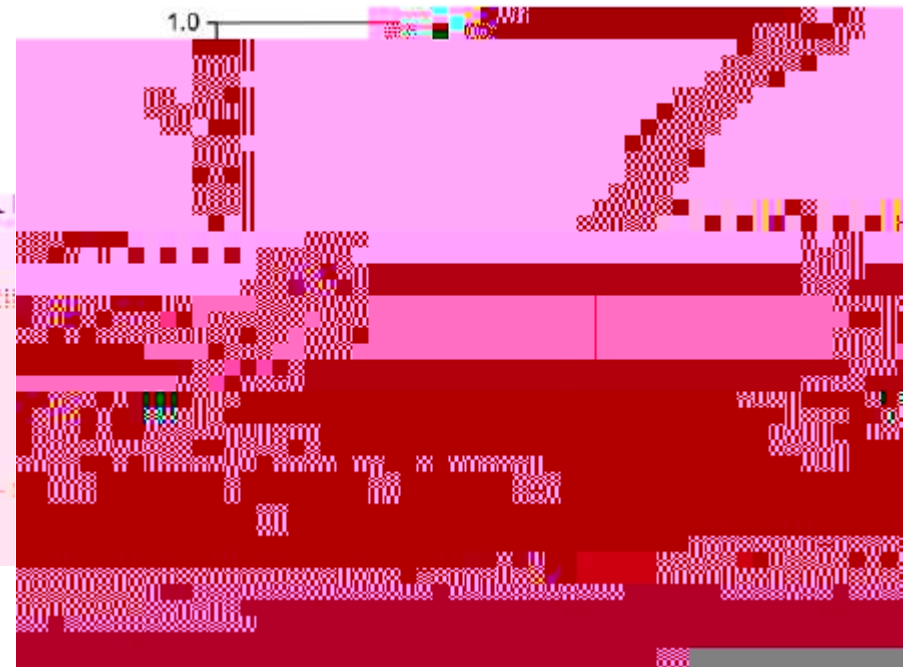
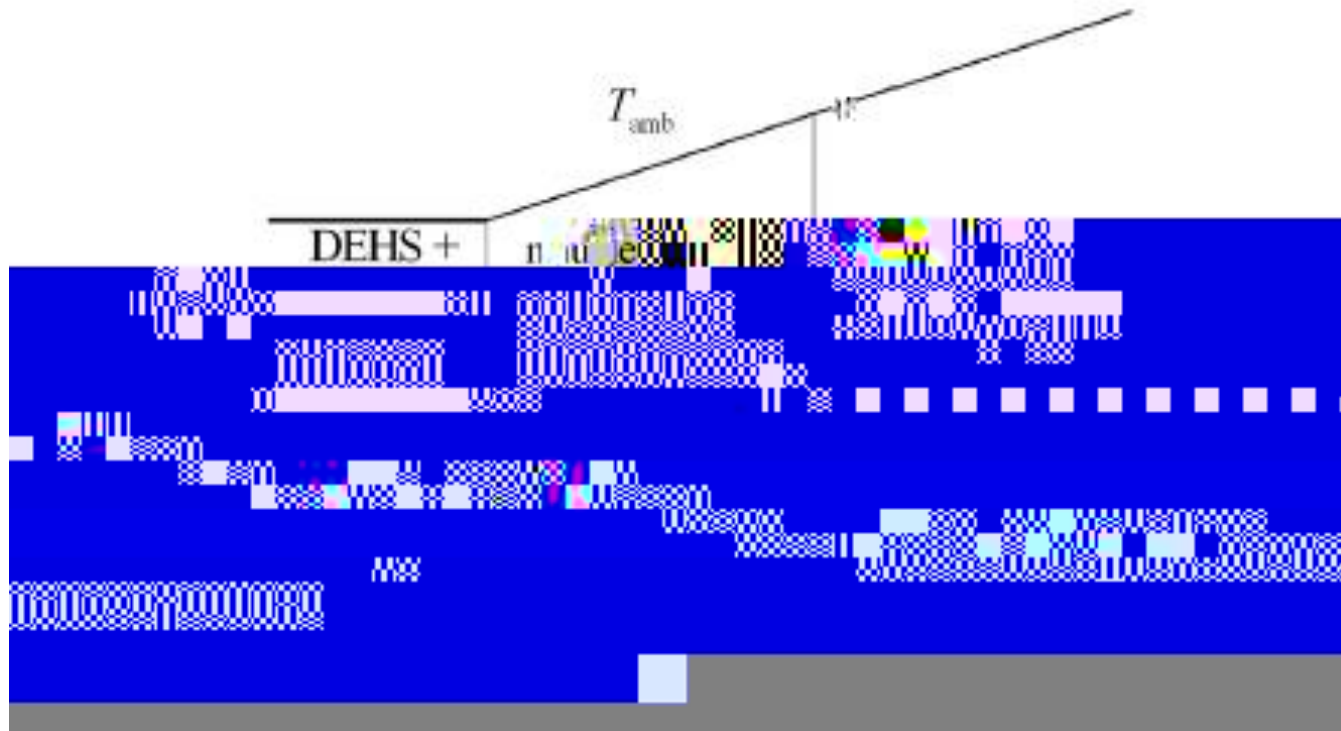

FIG. 4. Streamlines from numerical model $\alpha=0.05$: (1) $Da = 10^{-2}$, (2) $Da = 10^{-3}$.



A.K. Gilfanov, W. Koch, S.K. Zaripov Mathematical modeling of di-ethyl-hexyl-sebacate nanoparticle formation in a free turbulent jet under high nucleation rate conditions. Journal of Aerosol Science. - 2016. - V.96. - P.124-139.



Collaboration

Brighton University - Kazan University

2016-2018

Joint project Royal Society (UK) RFBR (Russian Federation)

Modelling of aerosols/sprays for medical and
automotive applications

Aerosol laboratory

- Head Prof. Shamil Zaripov, GAeF member

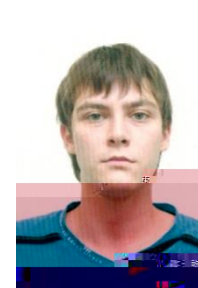
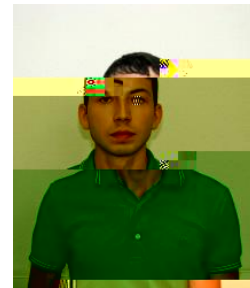
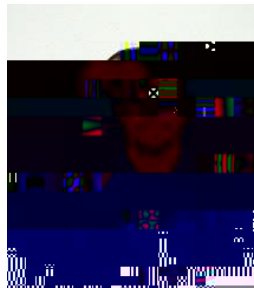
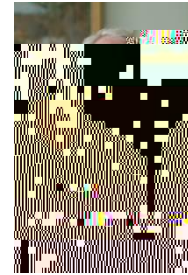

Founded in **1804**, Kazan University is the second oldest university in the Russian Federation, and now is an internationally acknowledged center of academic excellence.

Before 1878 Kazan University was the farthest Eastern university of the Russian Empire: its academic district included the Volga Region, Kama Region, Ural Region, Siberia and Caucasus.

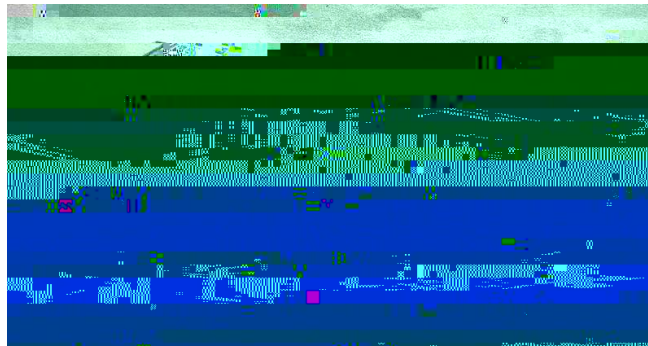

The main center of higher education for a vast region, KFU has over 47,000 students, who follow 310

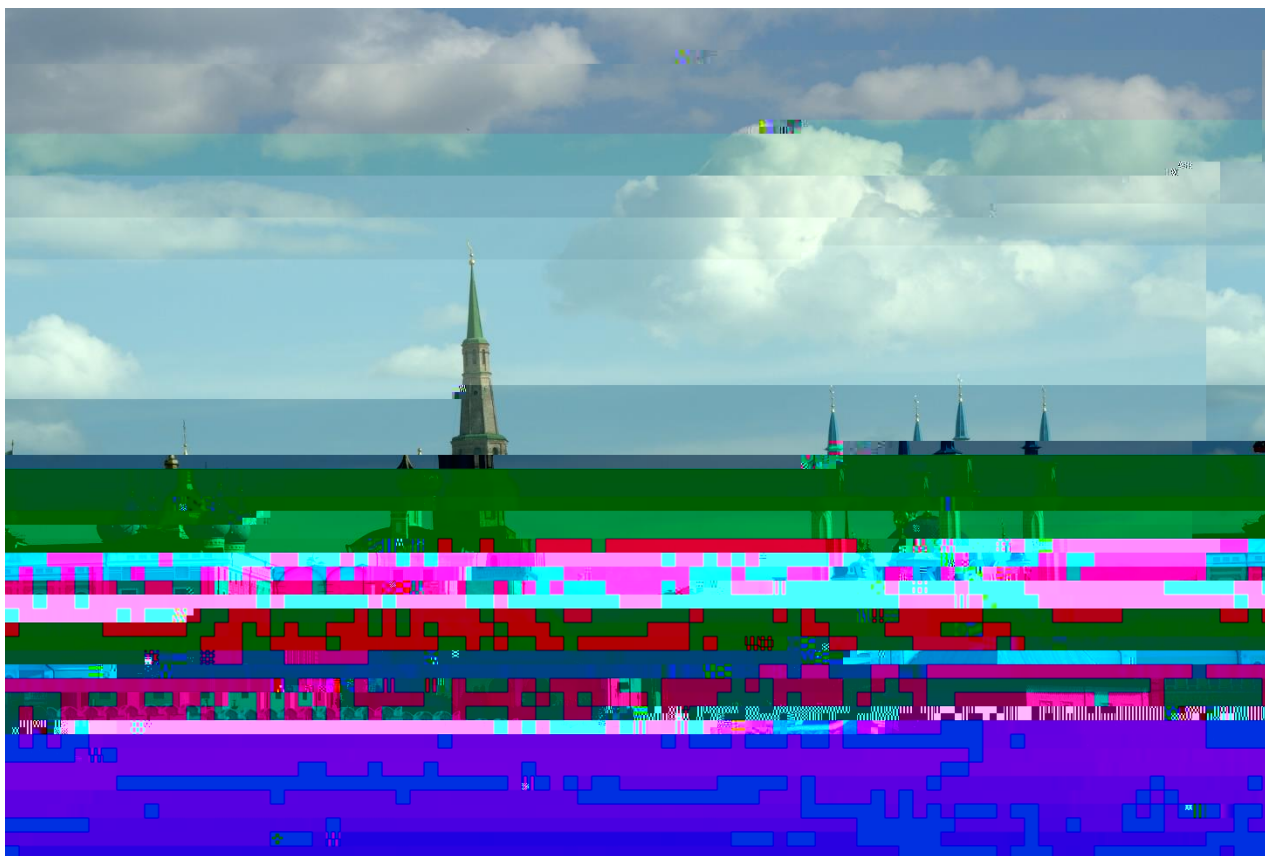

Thank you for attention